

TONS OF LIGHTING

**CineLight**

**480Quad®**

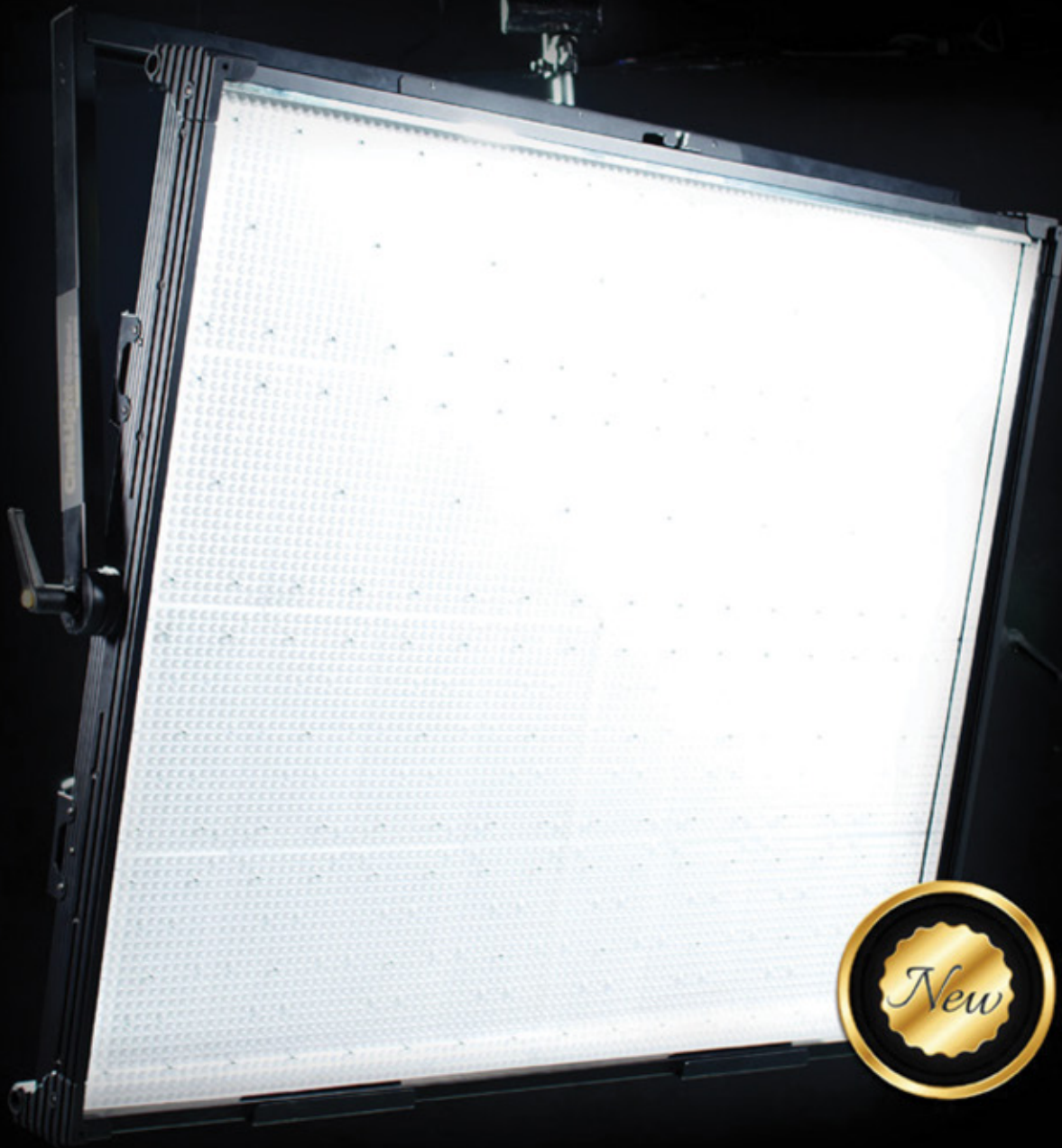

[www.fluotec.com](http://www.fluotec.com)  
[info@fluotec.com](mailto:info@fluotec.com)



## Studio Long Throw LED PANELS & Production SoftLight LED PANELS

Square configuration very high CRI/TLCI >90 color rendering indexes. Constant Output Tunable DMX LED PANELS.

Model	CineLight Studio 480 Super Quad® Tunable Long Throw
Code with Yoke	G6LCNT220
Operation	90-240V - 50/60Hz
Weight lb/kg	114.64/52
Electrical draw	7.03 (835 W) @120VAC
Remote variable CCT	2700 K - 6500 K and 8 presets
CRI	>90
Remote dimming control	Via DMX 0% - 100%
Local dimming control	Digital Display 0% - 100%

### Technical Specifications

- A very high efficiency broadcast & cinema luminaire with High-Speed option
- Constant luminous output (2700-6500 K) of CCT with proprietary designed calibration curves
- Local LED digital display panel for manual control
- Remote DMX control assigns 2 channels, dimming and color temperature
- Preset button for custom configuration of color temperatures
- 2 High-Speed values for Tungsten and Daylight CCT
- Interchangeable diffusion panel
- **NEBULA®** reflective and diffusion chamber technology
- 50° LED intensifiers
- Integrated power supply

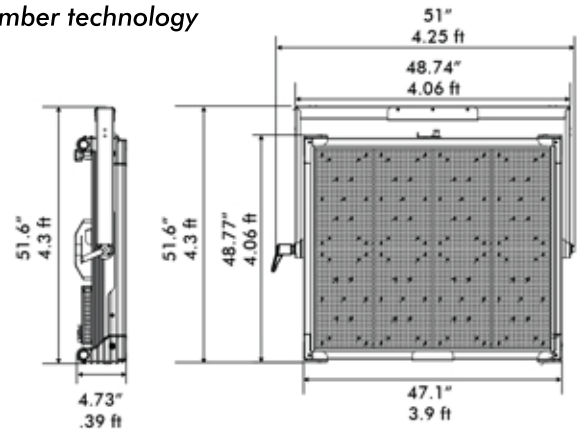

Photometric Data	6.00 ft	9.00 ft	12.00 ft
------------------	---------	---------	----------

Illuminance E Foot-Candles/lux



### CineLight Studio 480 Super Quad® Long Throw LED PANEL

#### CineLight Studio 480 Super Quad® Long Throw LED PANEL Neutral White

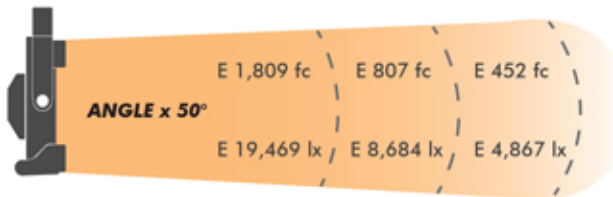







Without **Interchangeable** Diffusion Panel

#### CineLight Production 480 Super Quad® Long Throw LED PANEL Neutral White



With **Interchangeable** Diffusion Panel

-  Gel Frame  
G6CNT222
-  Interchangeable  
Diffusion Panel  
G6LCNT221
-  16 ft POWERCON AC  
Cable without Switch  
G6CNT156
-  Safety Cable (2x)  
G6FLT059
-  Yoke
-  C-Clamp  
G6FLT262

